

# Mountain Hardware, Vaude, OR, Hennessy Hammocks and Bivy Bags

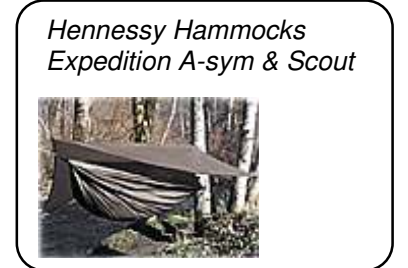

Model	Persons	Use	Fly Fabric	Floor Fabric	Vestibules & Doors	Minimum Weight	Price
Trango 2.1 (special order only)	2	ski touring / 4 season	70D Silicon Nylon	Nylon PE 5000mm	2 doors & 2 vestibules	4.13 kg	\$1199
Vaude Hogan Ultralight	2	3 season	40D Silicon Nylon 3000mm	40D Nylon 10000mm	1 door & 1 vestibule	1.45 kg	\$599
OR Nighthaven	2	3 season	30D Silicone Nylon	Optional floor 70D Nylon	1 door	1.03 kg 0.42 kg floor	\$299 \$89 floor
Hennessy Hammock Expedition A-sym	1	3 season	-	-	-	1.26 kg	\$219
Hennessy Hammock Expedition Scout	1	3 season	-	-	-	1.26 kg	\$139

VAUDE	Use	Upper Fabric	Floor Fabric	Features	Weight grams	Price
Bivi	Bivy	Polyamid breathable	polyamid	Fly screen, Hood zip, Optional pole	990 g	\$299
OUTDOOR OR RESEARCH						
Aurora Bivy	Bivv	Gore-Tex Respiration	Hydroseal	Fly screen, Hood zip	660 g	\$329
Alpine Bivy	Bivy	Gore-Tex Respiration	Hydroseal	Fly screen, Hood zip, Optional pole	870 g without 910 g with pole	\$399

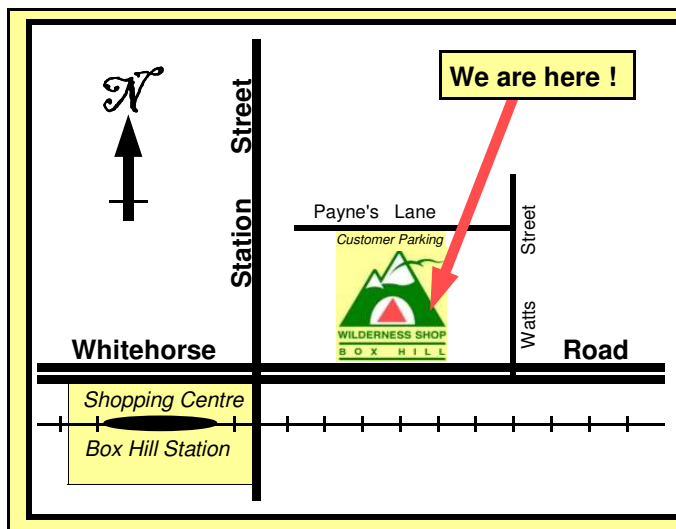

## THE WILDERNESS SHOP

Equipment Specialists in  
Adventure Travel, Bushwalking,  
Rock Climbing and Cross Country Skiing.

[www.wildernessshop.com.au](http://www.wildernessshop.com.au)

969 Whitehorse Road  
BOX HILL VIC 3128  
Tel: (03) 9898 3742  
Fax: (03) 9899 5398  
E: [info@wildernessshop.com.au](mailto:info@wildernessshop.com.au)  
ABN 25 005 722 010

Open:  
Mon to Wed 9:00-5:30  
Thursday 9:00-6:00  
Friday 9:00-7:30  
Saturday 9:00-5:00  
Sunday 11:00-4:00

Prices correct at time of printing, but are subject to change. Weights and measurements are supplied by the manufacturers. Suggested use is based on Australian conditions.



www.Salewa.it

<b>Model</b>	<b>Persons</b>	<b>Use</b>	<b>Fly Fabric</b>	<b>Floor Fabric</b>	<b>Vestibules &amp; Doors</b>	<b>Minimum Weight</b>	<b>Price</b>
Sierra Leone II	2	4 season / ski touring	Stormshed Polyester 5000mm	Hydroshed PU 10000mm	2 vestibules 2 doors	3.8 kg	\$569
Denali II	2	2-3 season	Stormshed Polyester 4000mm	Stormshed Polyester 4000mm	2 vestibules 2 doors	2.8 kg	\$359
Denali III	3	2-3 season	Stormshed Polyester 4000mm	Hydroshed PU 5000mm	2 vestibules 2 doors	3.4 kg	\$389



**Pitching**

All Salewa tents pitch the inner first, which quickly clips to the poles. The outer fly is then put over the inner and clipped to the pole ends.



www.exped.com

**SWISS QUALITY DESIGN : What makes Exped tents so unique?**

- Easy setup with minimum pegs
- Strong and weatherproof
- Excellent ventilation
- Loads of space
- Multifunctional and simple to use
- Quality materials and workmanship

Model	Persons	Use	Fly Fabric	Floor Fabric	Vestibules & Doors	Minimum Weight	Price
Gemini 3	3	3 season	PU/Silicon Ripstop Nylon	PU Nylon 5000 mm	2 vestibules & 2 doors	2.55 kg	\$599
Vela 1	1	3 season	PU Ripstop Polyester	PU Nylon 10000 mm	1 vestibule & 1 door	1.55 kg	\$419
Vela 1 Extreme	1	3 season	Silicon Ripstop Nylon	PU Nylon 10000 mm	1 vestibule & 1 door	1.45 kg	\$449
Vela 1 Ultralight	1	2-3 season	15D PU/Silicon Ripstop Nylon	40D PE Ripstop Nylon 10000mm	1 vestibule & 1 door	1.20 kg	\$449
Venus II	2	4 season / ski touring	PU Ripstop Polyester	PU Nylon 10000 mm	2 vestibules & 2 doors	2.75 kg	\$679
Venus II Extreme	2	ski touring / 4 season	Silicon Ripstop Nylon	PU Nylon 10000 mm	2 vestibules & 2 doors	2.60 kg	\$699
Venus II Ultralight	2	3-4 season	15D PU/Silicon Ripstop Nylon	40D PE Ripstop Nylon 10000mm	2 vestibules & 2 doors	2.10 kg	\$649

**Gemini 3**

**Designed for the Australian Adventurer: YOU!**



A careful balance between **light weight** and **durability**, **generous internal space**, **continuous pole sleeves** for increased stability, **quick set-up**, vestibule design ensures **no drips** into tent interior.

**Internal dimensions:**

**Gemini 3:** 2200mm long, 1600mm wide, 1150mm high

**Vela 1**

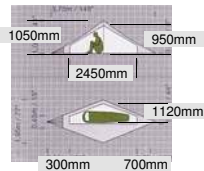

**All Vela I Models:**

**Very light**, spacious, quick setup time (1.5 minutes!)

**Large vestibule** to store gear, all within easy grasp from within the tent.

**Dyneema core guylines** are superstrong, combined with ample tent peg loops for stability in high winds.

**New Vela I Ultralight**

**Even further weight reduction** on the Vela I Extreme

Use: 2-3 season

Fly Fabric: 15D Silicon/PU Nylon

Floor Fabric: PE Nylon 10000mm

Minimum Weight: 1.2 kg

Maximum Weight: 1.5 kg

Poles: DAC Featherlite 9mm aircraft aluminium

**Venus II**

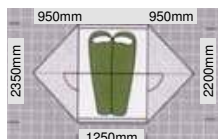

**All Venus II Models:**

**Quick & easy to pitch:** color coded poles glide into matched continuous sleeves.

**Guy lines attached directly to pole sleeves** for stability in wind.

**One inner door is larger** allowing 2 people to sit side by side.

**One vestibule has a loft** for wet gear.

**Great ventilation** with opposing doors and windows.

**New Venus II Ultralight**

**25% weight reduction** on the Venus II Extreme

Use: 3-4 season

Fly Fabric: 15D Silicon/PU Nylon

Floor Fabric: PE Nylon 10000mm

Minimum Weight: 2.1 kg

Maximum Weight: 2.4 kg

Poles: DAC Featherlite 10.25mm & 9mm aircraft aluminium



www.wildequipment.com.au

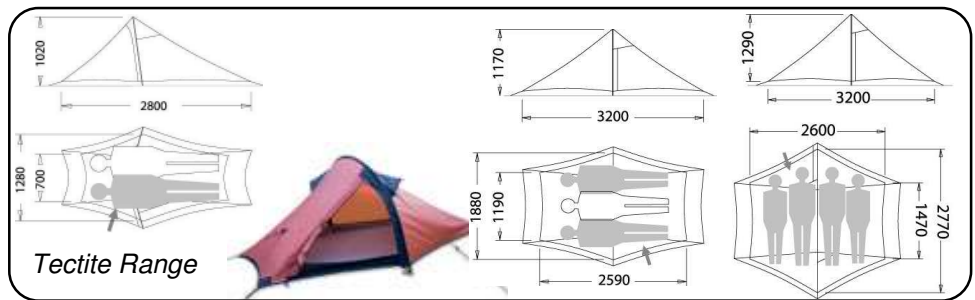

Model	Persons	Use	Fly Fabric	Floor Fabric	Vestibules & Doors	Minimum Weight	Price
Tectite 1	1-2	lightweight 3 season	Silicon/PE 30D Poly ripstop 1500mm	PE Nylon 5000mm	1 door	1.23 kg	\$359
Tectite 2	2-3	lightweight 3 season	Silicon/PE 30D Poly ripstop 1500mm	PE Nylon 5000mm	1 door	1.76 kg	\$449
Tectite 4	4	lightweight 3 season	Silicon/PE 30D Poly ripstop 1500mm	PE Nylon 5000mm	1 door	2.18 kg	\$499
First Arrow <i>UL</i>	2-3	ski touring / 4 season	Siliconised Polyester 4000mm	PU Nylon 8000mm	2 vestibules 1 door	3.00 kg	\$795
First Arrow Standard	2-3	4 season / ski touring	Polyester ripstop 3000mm	PU Nylon 8000mm	2 vestibules 1 door	3.15 kg	\$695
Second Arrow <i>UL</i>	2	ski touring / 4 season	Siliconised Polyester 4000mm	PU Nylon 8000mm	2 vestibules 1 door	2.28 kg	\$599
Dart 2 / Dart 2 <i>UL</i>	2	3 season	Polyester 3000mm/ SN240	PU Nylon 8000mm	2 vestibules 2 doors	2.85 kg 2.55 kg	\$499 \$579
Dart	1	3 season	Siliconised Polyester 4000mm	PU Nylon 8000mm	1 vestibule 1 door	1.95 kg	\$479
I-Explore	3	4 season	Polyester ripstop 3000mm	PU Nylon 8000mm	2 vestibules 2 doors	3.75 kg	\$499
Overhangs (7 available)	2m x 3m 3m x 3m 3m x 4.5m	2 season	Poly ripstop OR Silicon Poly	none	none	0.78 kg 0.72 kg	\$99 to \$289

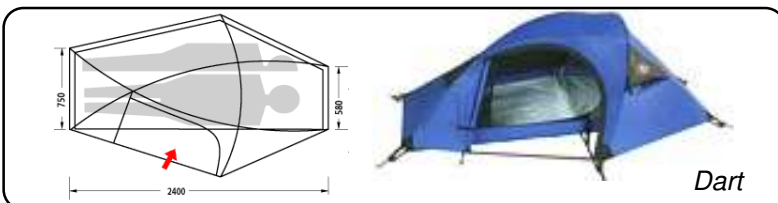
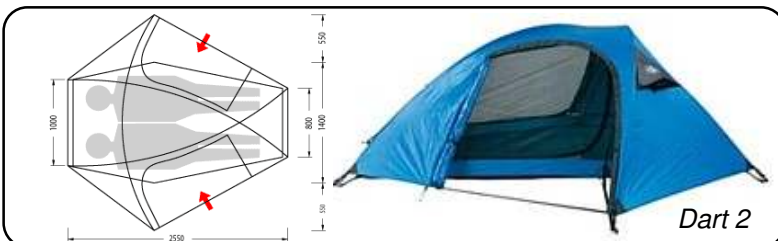
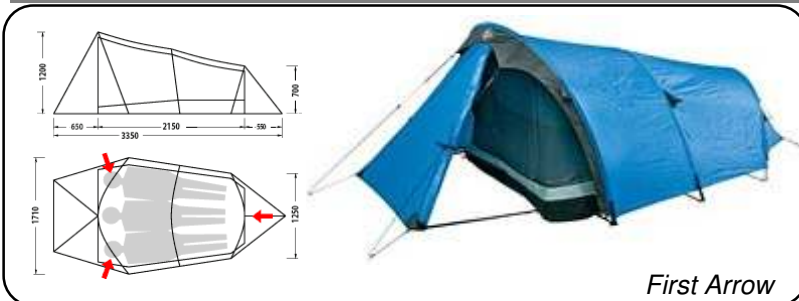

**Pitching**

WE tents, except for the *Dart Dart 2 & I-Explore*, are 'external pitch' design, meaning they can be put up or pulled down in the rain with only the outer getting wet. The outer can be used alone as a lightweight shelter. The inner tent is quickly clipped under the outer. Separate bags are provided for ease of packing and carrying. The *Dart & Dart 2* pitch inner first, and either the inner or outer can be used alone for a lightweight shelter.

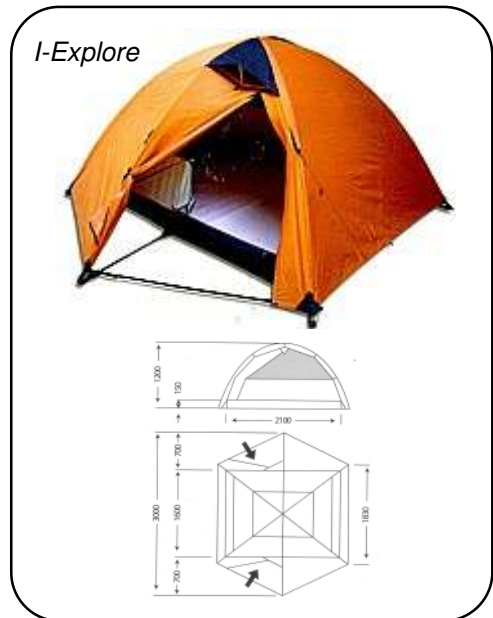



www.mont.com.au

**Something Better.**

“It is unwise to pay too much. But it’s worse to pay too little. When you pay too much, you lose a little money, that is all. When you pay too little, you sometimes lose everything, because the thing you bought was incapable of doing the thing you bought it to do.” *John Ruskin 1819-1900*

Model	Persons	Use	Fly Fabric	Floor Fabric	Vestibules & Doors	Minimum Weight	Price
Epoch	2	ski touring / 4 season	40D Ripstop Sil-Nylon	PU Laminate 10000mm	2 vestibules & 2 doors	3.55 kg	\$799
Firefly <i>Great combination of weight and space!!!</i>	2	3-4 season	Ripstop Polyester	PU Nylon 8000mm	2 vestibules & 2 doors	2.70 kg	\$549
Moondance 1	1	3 season	30D Ripstop Sil-Nylon	PU Nylon 10000mm	1 vestibule & 1 door	1.42 kg	\$399
Moondance 2	2	3 season	30D Ripstop Sil-Nylon	PU Nylon 10000mm	2 vestibules & 2 doors	1.86 kg	\$499
Moondance 3	3	3 season	30D Ripstop Sil-Nylon	Pu Nylon & 30D Ripstop Sil-Nylon	2 vestibules & 2 doors	2.58 kg	\$579
Batwing 3 Tarp	3	2 season	30D Ripstop Sil-Nylon	none	none	1.00 kg	\$149
Batwing 5 Tarp	5					1.25 kg	\$189

**Epoch**



The *Epoch* is a true 4 season free standing alpine tent with a unique 6-pole design providing enormous stability in high winds. In fact wind tunnel testing showed that the addition of the ridgepole increased overall stability by an amazing 40%. The *Epoch* is a very generous 2 person dual entrance dual vestibule design and features large 3 way roof vents for increased comfort over all conditions. Constructed with durability in mind the PU Laminated floor is rated at over 10,000mm while the PU coated seam sealed fly is made from a highly tear resistant 40 denier Sil nylon. Other features include multi directional 3 point reflective guys, combination pole sleeve & clip system, Dac Poles, gear loft and 4 large internal pockets.

Dimensions: 220cm long, 145cm wide, 100cm high

**Firefly**

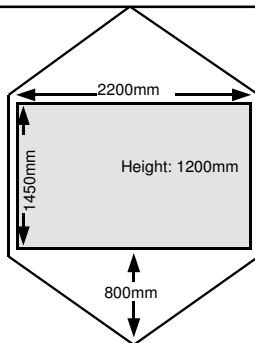

The *Mont Firefly* has been specifically designed as the best all-round tent for 3-4 season use in Australian conditions. The Firefly represents an unbeatable combination of maximising space while keeping weight at a comfortable limit for 2 people.

**Moondance 1**

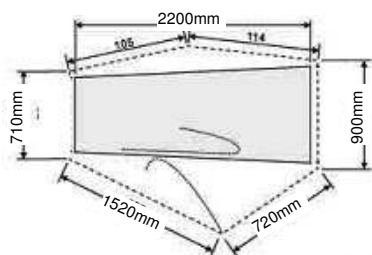

**Moondance 2**

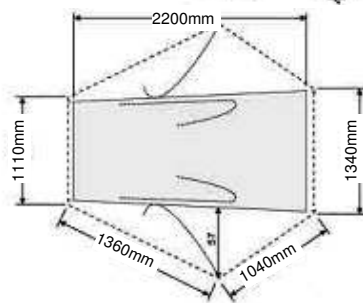

**Moondance 3**

